

LSD Series

Installation Illustration

1. Allowable tolerance of mounting surface

LSD series is an arc-shape, two-point contact design of linear guide. Its self-centering feature allows some tolerance on mounting surface without affecting the smoothness of linear motion. The allowable tolerance is indicated in following table:

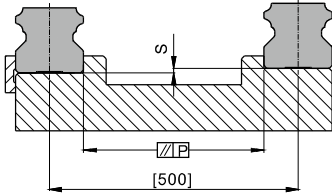

Model	Allowable tolerance of parallelism P(μm)			Allowable tolerance of top and bottom S(μm)		
	Standard clearance(A)	Light Preload(B)	Medium Preload(C)	Standard clearance(A)	Light Preload(B)	Medium Preload(C)
LSD15	25	18	-	130	85	-
LSD20	25	20	18	130	85	50
LSD25	30	22	20	130	85	70
LSD30	40	30	27	170	110	90
LSD35	50	35	30	210	150	120

Note: The value in the table is the allowable value when the distance between the two linear guides is 500mm, and the allowable value is proportional to the distance between the two linear guides.

2. Height and Chamfer of Reference Edge

In order to ensure accurate installation of LSD Linear Guide, the contact space should not exceed the given figures in following table.

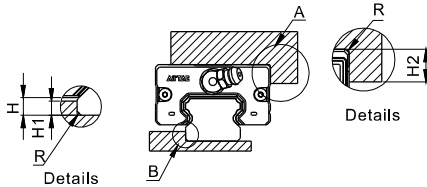

Unit : mm

Model	H	H1	H2	R(Max)
LSD15	4.5	2.7	5	0.5
LSD20	6	5	7	0.5
LSD25	7	5	7.5	1
LSD30	9	7	7	1
LSD35	11	7.5	9.5	1

3. Screw Tighten Torque

When installing linear guide, whether the screws are well tighten and surface is well contacted will affect accuracy significantly. Please refer to following table for tightening force to ensure a perfect installation.

Model	Screw size	Tighten Torque(N.cm)		
		Iron	Casting	Aluminum alloy
LSD15	M3	196	127	98
	M4	412	274	206
LSD20	M5	882	588	441
	M6	1370	921	686
LSD30	M6	1370	921	686
	M8	3040	2010	1470
LSD35	M8	3040	2010	1470

4. Installation and Application

Linear guide installation methods can be divided into the followings.

For installations other than forward installation, the lubricant may fail.

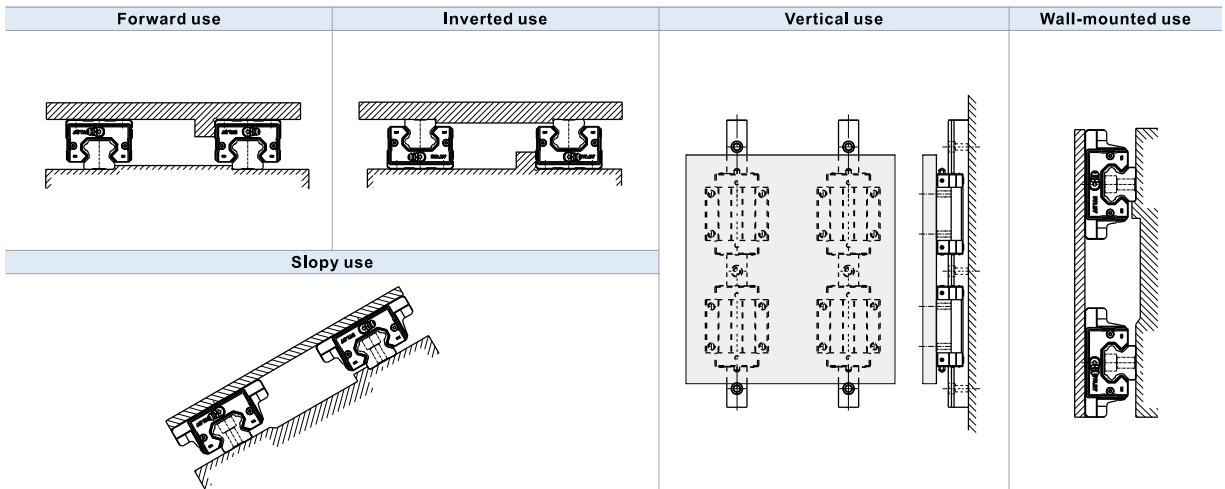

LSD Series

5. Datum plane

- Datum plane for installation must be ground or finely milled to ensure accuracy.
- Both sides of Rail can be used as the datum plane.
- For multi-blocks on a rail, identification line on blocks should be put on the same side to ensure moving accuracy.

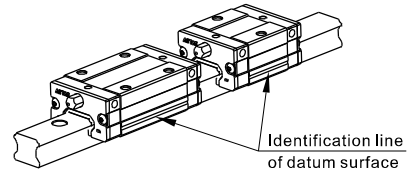

6. Fixation Method

Rails and blocks are possible to be displaced while the machine is subjected to vibrations and impacts thus to affect the accuracy. In order to avoid those difficulties and achieve high running accuracy, the following four methods are recommended for fixing.

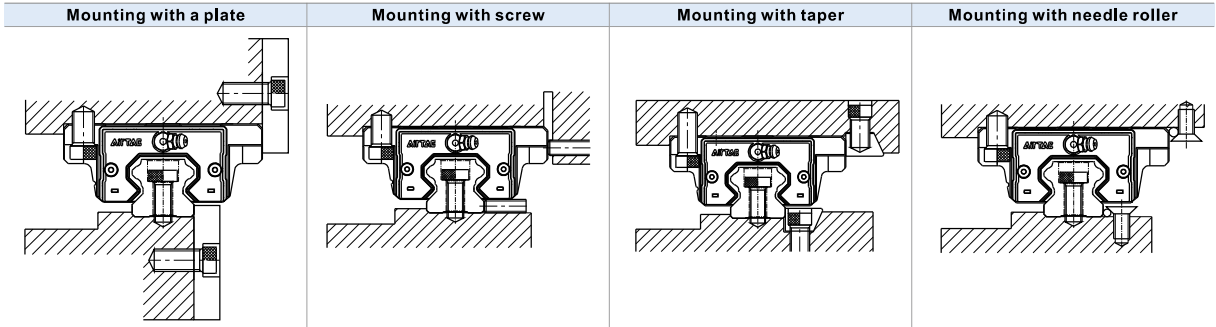

7. Rail Installation

A. Before installing the rail, remove all dirt from the mounting surface with oil stone, and then wipe with a clean cloth.

Remove all dirt from the mounting surface with oil stone, and then wipe with a clean cloth

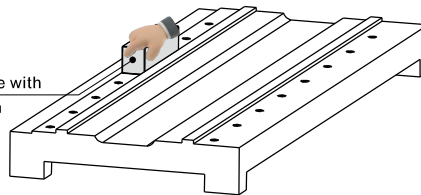

B. Place the rail gently on the bed firstly, then put the bolts into the mounting holes and pre-tighten them, place the rail ① into close contact with the datum plane of the bed by using the baffle, tighten the bolts with appropriate torque to fix the rail. Refer to "3. Screw tighten torque" for recommended torque value.

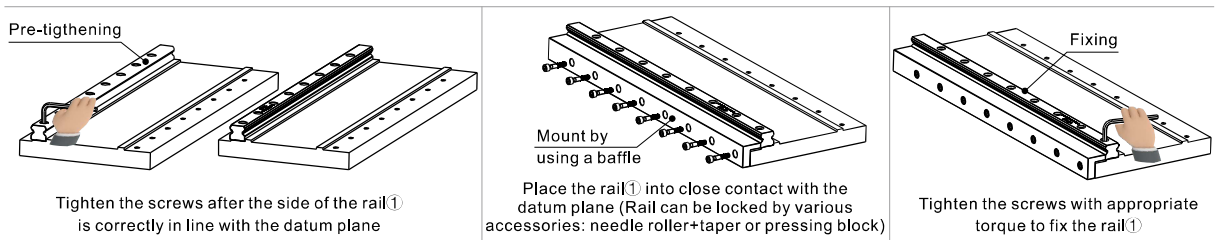

8. Block Installation

- Temporarily fix the table on the block by using the mounting bolts.
- Push the block datum plane against the side datum plane of the table and position the block by tightening the set screws.
- Tighten the mounting bolts in 1 to 4 sequences to fix the table on the block.

9. Subsidiary Rail Installation

Under the condition that the subsidiary rail has a reference datum plane, remove all dirt from the mounting surface with oil stone, and then wipe with a clean cloth, mount the subsidiary rail ② with the same method of the master rail ①.

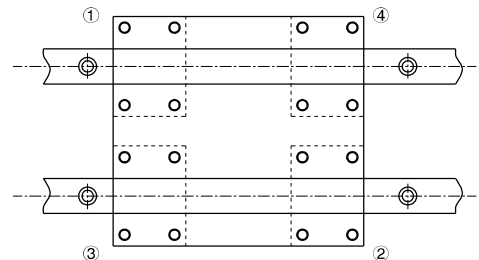
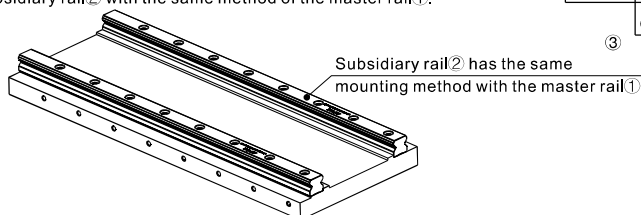

Under the condition that the subsidiary rail ② has a reference datum plane, remove all dirt from the mounting surface with oil stone, and then wipe with a clean cloth,

LSD Series

10. Rail Installation without Side Datum Surface

Using a provisional datum plane

Use the datum plane provided on the bed for straight alignment of the rail from one end to the other, attention must be paid to fix two blocks in close contact on the measuring plate.

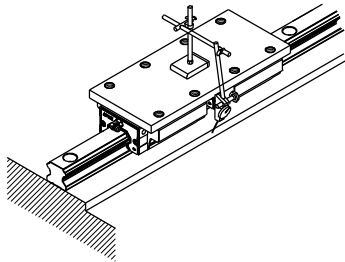

Using a straight-edge

Put the straight-edge between the two rails and use a dial gauge to adjust straight-edge in parallel with the side datum plane of the master rail. Use the dial gauge to ensure the straightness of the subsidiary rail by using the straight-edge as reference, then tighten the mounting bolts in proper sequence when the subsidiary rail is parallel to the master rail.

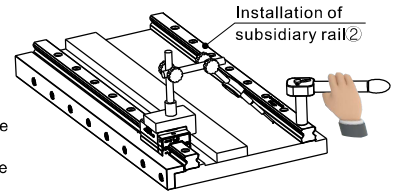

11. Rail Installation without Set Screws

To ensure parallelism between the subsidiary rail and the master rail in the condition without set screws, the following installation methods are recommended, and the installation of the block is the same as mentioned previously.

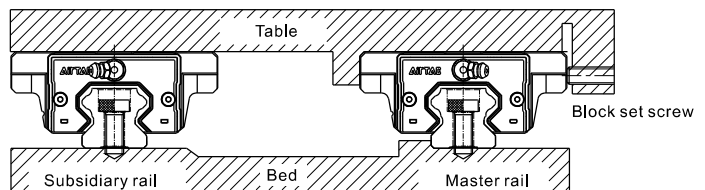

Installation of the master rail

Using a vice

Put the rail on the bed mounting surface and temporarily fasten the mounting bolts, then push the rail against the side datum plane of the bed by using a vice to ensure the rail position. Tighten the mounting bolts in proper sequence with specific torque.

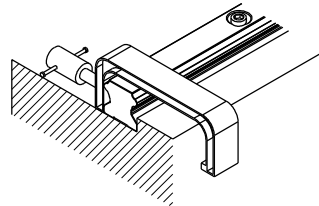

Installation of the subsidiary rail

Using a straight-edge

Put the straight-edge between the two rails and use a dial gauge to adjust straight-edge in parallel with the side datum plane of the master rail. Use the straight-edge to ensure the straightness of the subsidiary rail, then tighten the mounting bolts in proper sequence with specific torque.

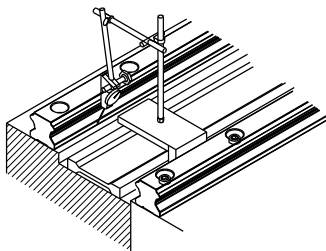

Using a table

Fix two blocks on the master rail to the table, and temporarily fix the subsidiary rail to the bed and one block on the subsidiary rail to the table. Place the gauge against the side surface of the block on the subsidiary rail, move the table from one end of the rail to the other end, then tighten the mounting bolts in proper sequence with specific torque while aligning the subsidiary rail parallel to the master rail.

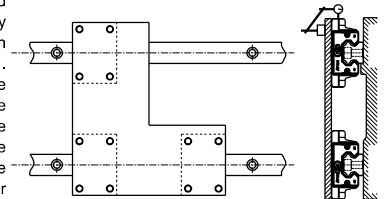

Following the master rail

Fix the table to the two blocks on the master rail and one of the two blocks on the subsidiary rail, temporarily fix the other block on the subsidiary rail to the table and subsidiary rail to the bed. Moving the table from one end of the master rail and tighten the mounting bolts on the subsidiary rail in proper sequence with specific torque at the same time.

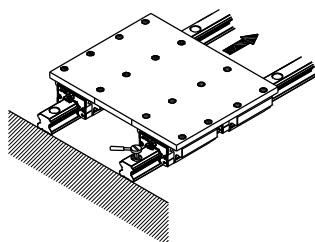

Using a jig

Use a special jig to help ensure the position of the subsidiary rail, and tighten the mounting bolts in proper sequence with specific torque.

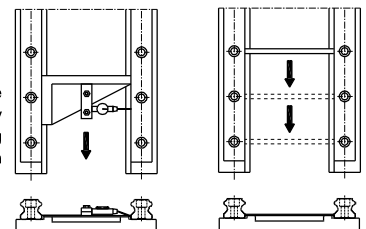

LSD Series

12. Rail Butt-jointed

- When it comes to butt-jointed rail installation, it must follow the butt-jointed marks shown below.
- In order to avoid the accuracy caused by installing the matched jointed rails, it is recommended to stagger the butt-jointed positions, see figure below.

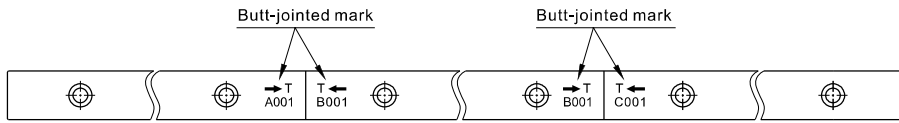

- When joining rails, it must follow group marks on rail to ensure the accuracy of linear guide. These marks are located on the top surface at joint side. Please put the same group marks together.

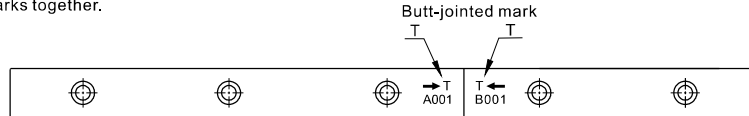

- Be aware serial number of group mark when assemble. A001 and B001 are in a group, so as to A002 and B002 and so on.
- Be aware the installation direction while assembly, the serial numbers are not upside down and arrows point to each other.

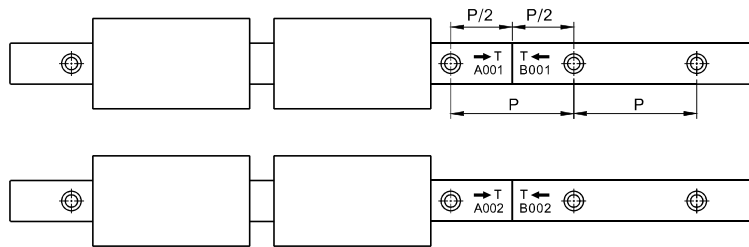

13. Measurement Method after Installation

When measuring running accuracy of the block, two blocks should be fixed on an inspection table in close contact to obtain stable accuracy.

When using a dial gauge, a provisional benchmark (like a straight-edge) is recommended to put as close as possible to the block for accurate measurement.

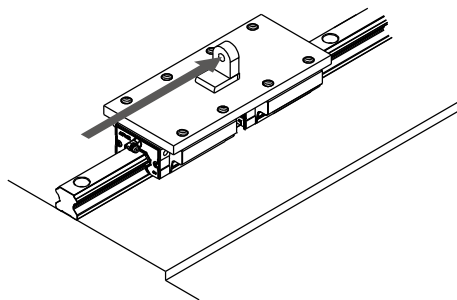

Method using an autocollimator

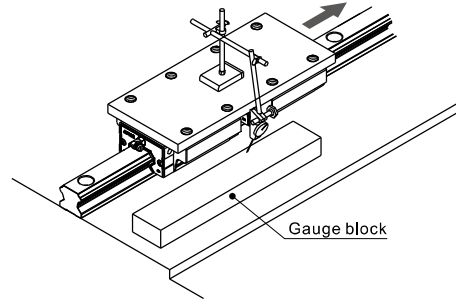

Method using a dial gauge

LSD Series

Lubrication method

When a linear guide is well lubricated, it can reduce wear and increase lifespan significantly. Lubrication has the following benefits :

- Reduces friction of the rollers and raceway to minimize wear.
- The grease film between contact surface can prevent roller fatigue.
- Prevent rust.

1. Lubrication Grease

Use the correct grade of lubrication. While lubricating, a grease gun can be used to pump grease into slider through the grease nipple on it. The suitable condition for lube is when working speed is under 60 m/min and not in cooling process.

•Nipple type

	L-P-M4	L-P-M6	L-P-SM6
Grease nipple type			
	LSD15	LSD20 LSD25 LSD30 LSD35	LSD20 LSD25 LSD30 LSD35

•Grease amount

LSD series linear guide is well lubricated with 'Shell Alvania grease S2' in factory. Customers are recommended to use identical or the same grade of lubricant. After lubrication, block needs to be moved back and forth at least three times for the length of three blocks and repeat at least twice. Check if the surface of rail is well covered by grease film.

Model	Grease amount for the first lubrication(cm ³)		Replenishment amount(cm ³)	
	Short type	Standard type	Short type	Standard type
LSD15	0.5	0.9	0.2	0.3
LSD20	1.1	1.8	0.4	0.6
LSD25	1.8	3.2	0.6	1.0
LSD30	2.9	4.5	0.9	1.4
LSD35	4.1	5.9	1.3	1.8

•Lubrication frequency

Although the linear guides are well lubricated at factory and retains grease well, frequent lubrication is still necessary to avoid undesirable wear. Recommended lubrication period is every 100km of movement or every 3~6 months. (Refer to table on the top for suggested amount)

2. Lubricating oil

Recommended oil viscosity for lubrication use is about 30 to 150 cst.

Lubrication oil is suitable for all kinds of load and impact application, but not for high temperature use due to its tendency of vaporization.

•Adaptor

L-P-AM6	L-P-AM8	L-P-A01
LSH15	LSH35 LSH30 LSH25 LSH20	LSH35 LSH30 LSH25 LSH20
L-P-LM6	L-P-LM8	L-P-L01
LSH15	LSH35 LSH30 LSH25 LSH20	LSH35 LSH30 LSH25 LSH20

Note: After installation, the top surface of adaptor may be higher than block. Be careful about the interference while moving.

LSD Series

Lubrication method

•Oil supply rate

Loss of lubrication oil is faster than lubrication grease. Pay attention to sufficiency of oil while using.

Model	Oil amount for the first lubrication(cm ³)	Feeding Speed(cm ³ /hr)
LSD15	0.3	0.1
LSD20	0.5	0.15
LSD25	0.6	0.2
LSD30	0.8	0.25
LSD35	0.9	0.3

3. Grease nipple/adaptor installation

- Grease nipple or adaptor can be installed in the two sides of block for manual or automatic lubrication based on customer's requirement.
- There are a secondary set of lubricating ports on the side of the block. When using, it is not recommended to use the side with datum line unless necessary.
- Lateral nipple installation is not recommended for flange type blocks. (The grease / oil nipple may interfere with block)
- If lateral lubrication is needed for above spec, please contact us for customization.

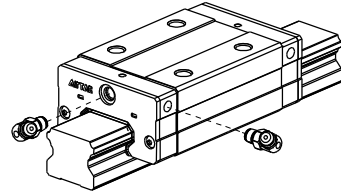

Bolt hole plug

1. Plug type

In order to prevent metal swarf or external objects from entering blocks and affecting precision and lifespan, customers must put plugs into holes during installation. Every rail is equipped with default plugs.

Model	Bolt	Diameter(D)(mm)	Thickness(H)(mm)
LSD15	M3	6.15	1.2
	M4	8.15	1.1
LSD20	M5	9.65	2.5
LSD25	M6	11.4	2.5
LSD30	M6	11.4	2.5
	M8	14.4	3.5
LSD35	M8	14.4	3.5

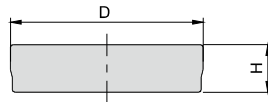

2. Plug installation Steps

Step one

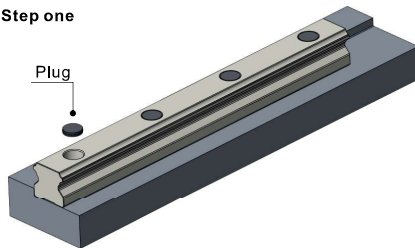

Place the plug in counterbore.

Step two

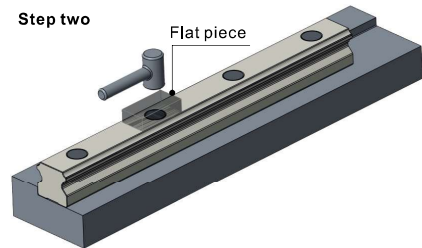

Place the flat piece on mounting hole, hit the piece vertically with a plastic hammer and fix the plug into counterbore.

Note :

- Please make sure the plugs do not protrude the rail surface.
- After installation, please clean the surface before use.

LSD Series

Dust prevention illustration

1. Code and structure

AirTAC provides the following dust prevention accessories for the linear guides working in dusty environment, if the following accessories are demanded, please add the corresponding code when ordering.

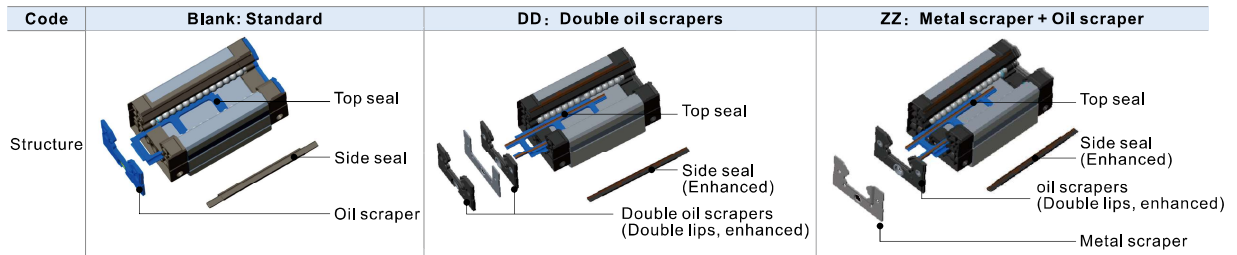

2. Test for high dust prevention

2.1. Test item

Test medium	Wood chip	Iron filing	Gravel
Running distance	500km	500km	500km

2.2. Test equipment

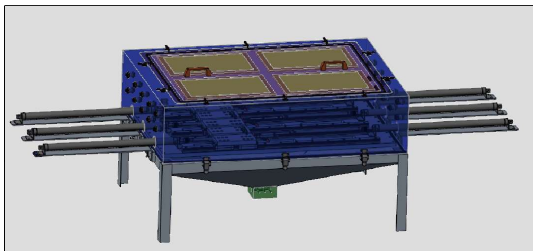

Figure1: Dust tester (Appearance)



Figure2: Dust tester (Inside)

2.3. Test condition

AirTAC adopts the industry's first dust tester (Figure 1) to simulate real working conditions, 360° without dead angles, all-round dust invasion (Figure 2). The dustproof test simulates multiple application scenarios, fully fill the air with wood chips, iron filings and gravels and are strictly tested to ensure the quality and dustproof effect of each block.

2.4. Test result

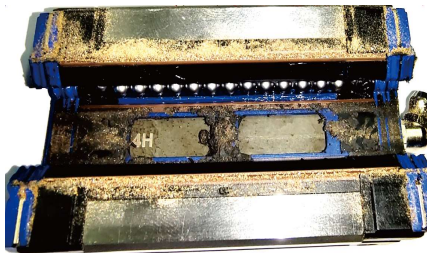

Figure3: Steel balls



Figure4: Steel balls

Result: It can be seen from the Figure 3 and 4 that little amount of dust enters the inside of the block after testing, and the steel ball surface is still smooth, the block still runs smoothly and the performance is not affected.

Note: The above test results are obtained from AirTAC lab.

3. Dimensions

Highly dustproof type blocks have different length compared with the standard blocks (only dimension C is different from the standard, the others keep same), see the table on the right for details.

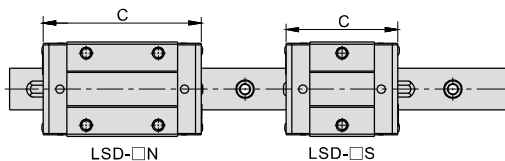

Model	Type	Length C(mm)		
		Standard (Blank)	Double oil scrapers(DD)	Oil scraper+Metal scraper(ZZ)
LSD15□S	Short	40.5	47.5	45
LSD15□N	Standard	57	64	61.5
LSD20□S	Short	46	53	50.5
LSD20□N	Standard	65	72	69.5
LSD25□S	Short	59	66	63.5
LSD25□N	Standard	83	90	87.5
LSD30□S	Short	68.5	76.5	73.5
LSD30□N	Standard	97	105	102
LSD35□S	Short	73.5	81.5	78.5
LSD35□N	Standard	106.5	114.5	111.5

Precautions on use

1. Block disassembly

With ball retainers and a dustproof cover, normally the balls are prevented from falling out when block is removed from rail. However, if obliquely insert rail into blocks or quickly assembled or disassembled, there is a risk for balls of falling out. Please carefully assemble the linear guide or use plastic rails to assist.

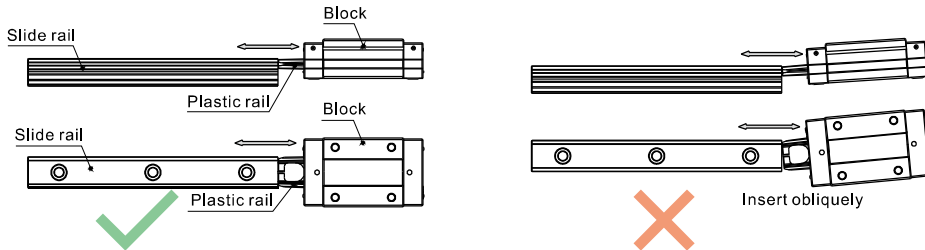

2. Plastic rail installation

A plastic rail is equipped for block set. Please do not remove plastic rail whenever it is not necessary. If plastic rail falls out and needs to be reinstalled, press the dustproof covers with fingers and install slowly to prevent balls from falling out due to misalignment of plastic rail.

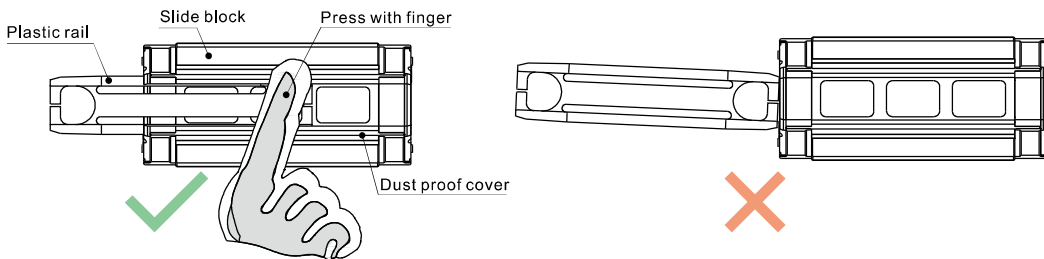

Press the dust-proof covers and insert plastic rail in alignment.

Without pressing dust-proof covers or insert plastic rail obliquely.

3. Caution

- Parts may slide out if linear guide is put unevenly. Please be careful.
- Hitting or dropping linear guide could have huge effect on accuracy and lifespan even though appearance may remain intact. Please be careful.
- Do not disassemble linear guide as external objects may enter blocks and cause accuracy problem.

4. Lubrication

- Linear guide have been treated with anti-rust oil during production. Before use, wipe the rail and treat it with lubrication.
- Do not mix lubricating oil (grease) with different properties.
- After lubrication, move block back and forth for the length of three blocks long and repeat at least 2 times to ensure there is a grease file on rail.

5. Use

- The operating environment temperature should not exceed 80°C, and the maximum temperature should not exceed 100°C.
- Do not separate blocks from rail whenever it is not necessary. If you need to separate them, please use plastic rails to prevent steel balls from falling out.

6. Storage

- When storing blocks, rails or linear guide set, please be sure that anti-rust oil is well applied and product is well sealed as well as placed horizontally. Avoid humidity and high temperatures environment.